



MiMo ROOFTOP ANTENNA

RAIL ROOFTOP ANTENNA WITH GPS

The MiMo Rooftop Antenna is designed specifically for use on trains, trams and buses. Incorporating two elements operating wideband across all frequencies from 698MHz to 6000MHz the MiMo Rooftop Antenna range is versatile and future proof. The MiMo series has two DC grounded radiating elements, in versions with a GPS module it is protected by an integrated gas discharge surge arrestor.

Housed in a high impact, flame retardant Polycarbonate housing, the MiMo Rooftop Antenna is weatherproof and environmentally sealed to IP67, ensuring that the antenna's performance is never compromised.

Technical Features

- Covers all LTE, WiFi & WiMAX frequencies used worldwide, including GSM-R, Cellular 700-6000MHz
- 2x Elements (700MHz to 6GHz)
- Optional active GPS GLONASS antenna with built in surge arrestor
- Compliant with rail standards, EN45545, EN50155, EN61373 & EN50121
- Housing Polycarbonate 1000 PEI & Aluminium base
- Industry standard 4 hole mount
- DC Grounded Elements
- Defined isolation and Correlation
- Rated IP67 (When installed according to the installation instructions)

Applications

- High speed trains & locomotives
- Trams
- Buses / coaches
- Mass transit systems
- Heavy duty machinery (quarry trucks etc.)

Ordering Information

MiMo Rooftop Antenna with GPS	1-2823592-1
-------------------------------	-------------

MiMo ROOFTOP ANTENNA

Rail Rooftop Antenna

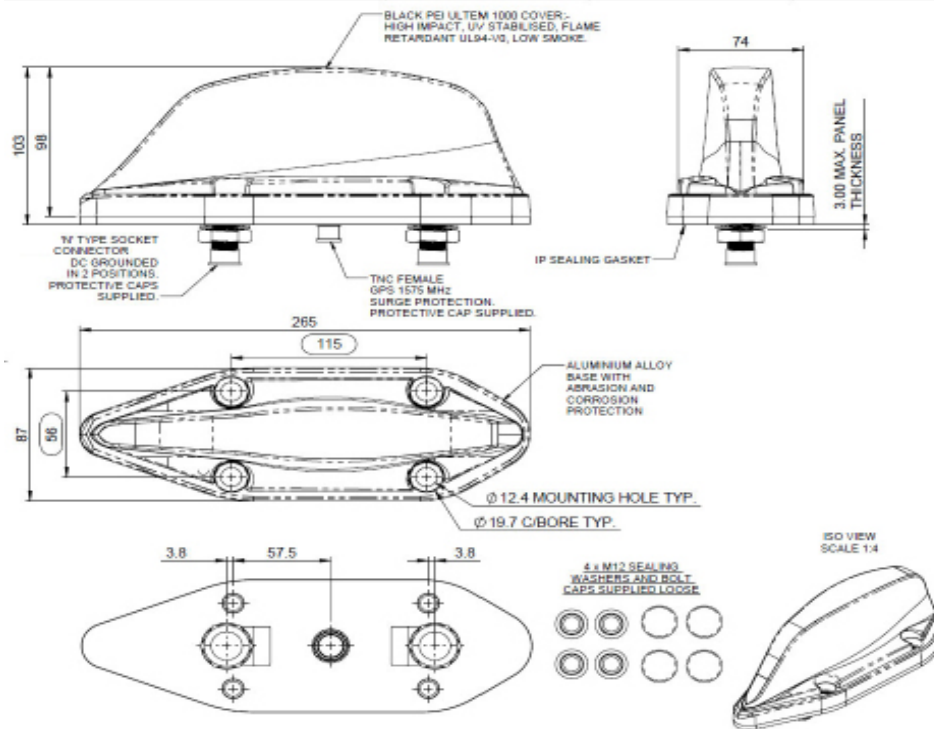

Typical VSWR*

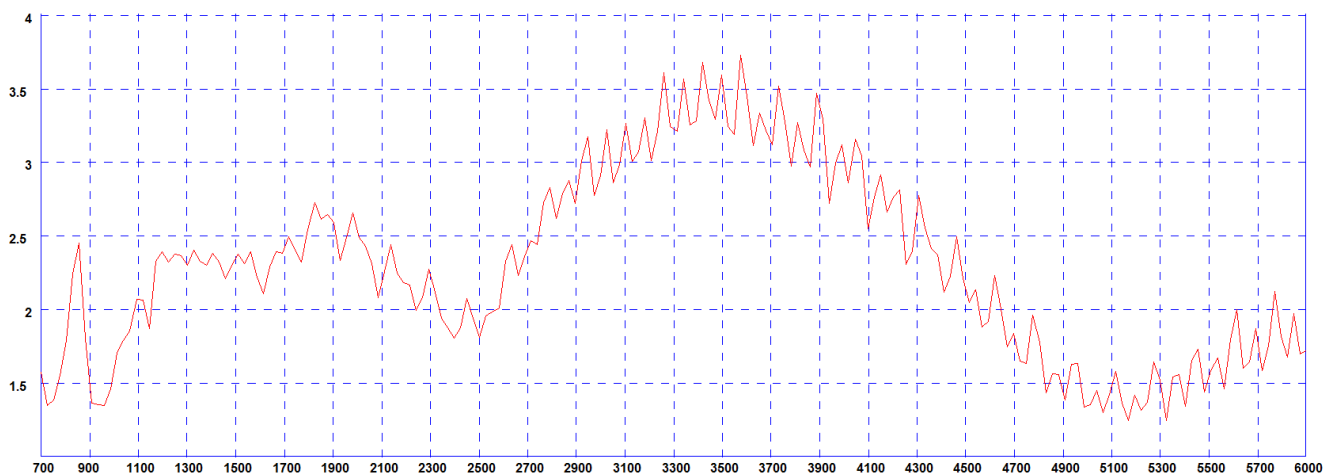

* Measured on a 600 x 600mm (2' x 2') ground plane with 1m (3') of low loss cable.

Typical E-Plane Pattern - (GPS) 1575MHz

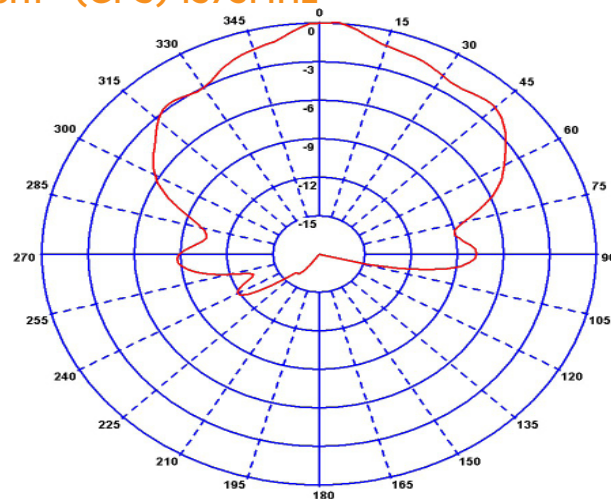

Typical 3D pattern - 700MHz

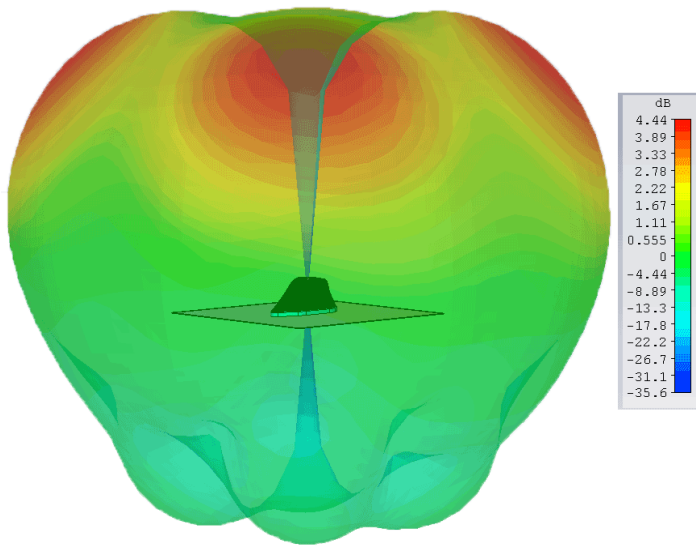

Typical 3D pattern - 900MHz

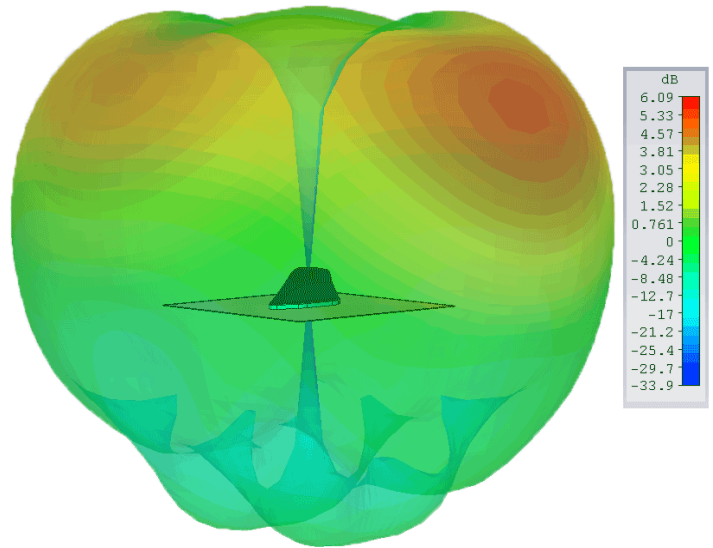

Typical 3D pattern - 1800MHz

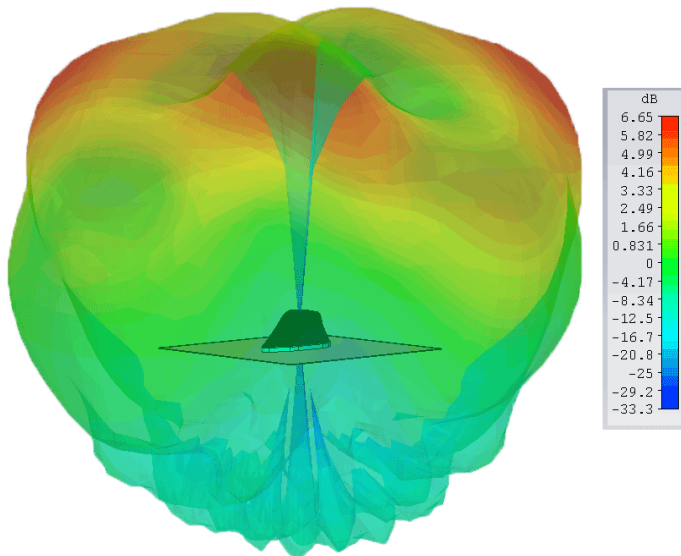

Typical 3D pattern - 2100MHz

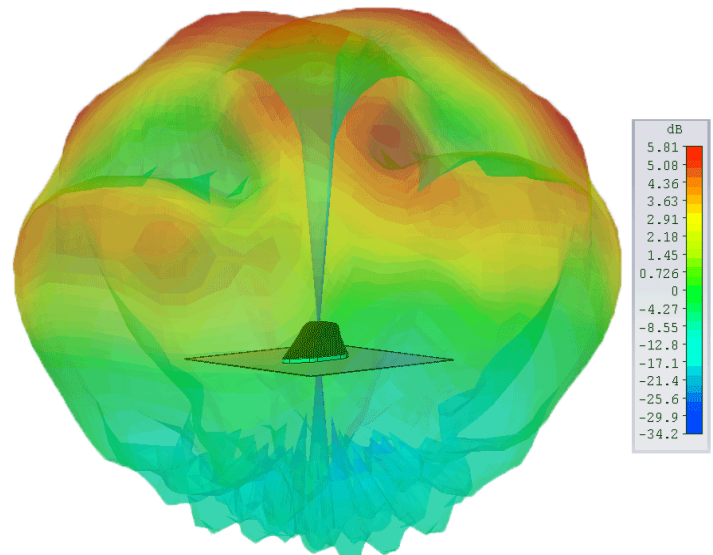

Typical 3D pattern - 2500MHz

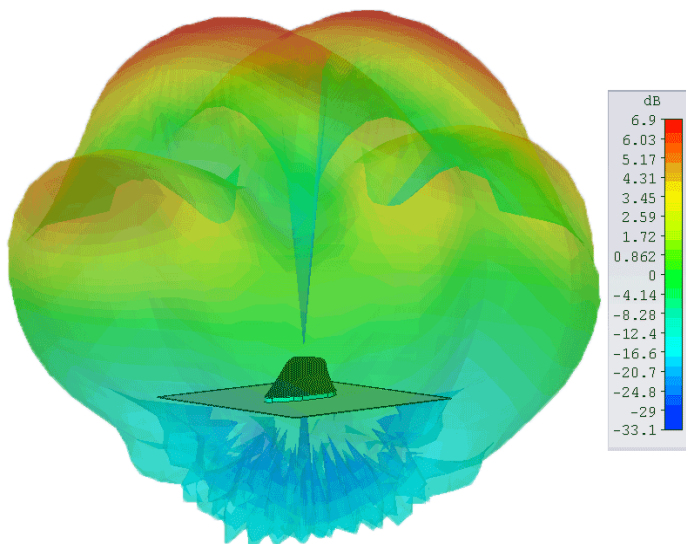

Typical 3D pattern - 5500MHz

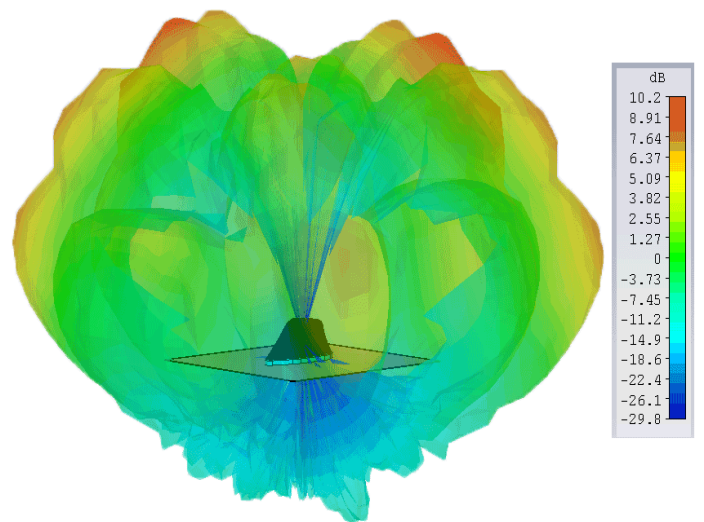

3D patterns simulated with both elements fed on a 600 x 600mm (2' x 2') ground plane without cable

MiMo Rooftop Antenna with GPS

Electrical Data

Frequency Range (MHz)	2 X 698-960 / 1700-6000 MHz	
Peak Gain Isotropic**	698-960	6dBi
	1710-2700	6dBi
	4.9-6GHz	10dBi
Polarisation	Vertical	
Typical VSWR*	<2.5:1	
Pattern	Omni-directional	
Impedance	50 Ω	
Max Input Power (W)	60	

GPS Data

Frequency Range (MHz)	1560-1612	
Impedance	50 Ω	
LNA Gain	26dB ± 3	
Polarisation	Right Hand Circular	
Operating Voltage	3-5V DC	
Current (Typical)	15mA	
GPS Antenna EMC Compliance	EN 301 489-1 V1.81 & EN 301 489-3 V1.6.1 EN 50121-3-2:2015	

Mechanical Data

Dimensions	Height (N/inc pad)	98mm (3.86")
	Width	87mm (3.42")
	Length	265mm (10.4")

Environmental Specification

Operating Temp	-50°C / +80°C (-58°F / +176°F)	
Radome Material	Polycarbonate 1000	
Radome Flame Retardance Rating	V0 (UL94)	
Base Material	Cast Aluminium (corrosion protected & powder coated)	
Sealing	IP67 (When installed according to the installation instructions)	

Approvals Data

Regulatory Approvals	EN50155:2007 (Dry heat & Cooling) EN61373:2010 / EN50155:2007 (Shock & Vibration) EN 45545:2013 (Fire & Smoke)	
----------------------	--	--

Mounting Data

Fixing	4x mounting holes to suit M12 bolts	
--------	-------------------------------------	--

Termination Data

Termination	Comms	2 x N (female) - DC grounded
	GPS	TNC (female) - surge protected

** Measured on a 600 x 600mm (2' x 2') ground plane with both elements fed and without cable.

* Measured on a 600 x 600mm (2' x 2') ground plane with 1m (3') of low loss cable.